

TYRE CHANGERS accessories

Helper



(for tilt back tyre changers)
 per smontagomme automatici



PLUS83H

Dispositivo premi-alza tallone pneumatico con braccio rotante
Air-driven helper with rotating arm
 Pneumatischer Hilfsmontagearm mit Zusatzhilfsarm
Dispositif pousse-lève talon pneumatique avec bras rotatif
 Dispositivo prensa talón neumático con brazo rotatorio

LEGENDA:



Vedi listino per maggiori dettagli
See pricelist for more details
 Siehe Preisliste für mehr Details
Voir tarif pour plus de précisions
 Ver lista de precios para más detalles



Montaggio in fabbrica
Factory assembled
 Werkseitig montiert
Montage in usine
 Montaje en fábrica

OPTIONS

Braccio addizionale
Additional arm
 Zusatzarm
Bras additional
 Brazo suplementar

Non possono essere abbinati fra loro.
The cannot be combined together.
 Nicht zusammen montierbar.
Ne peuvent pas être combinés ensemble.
 No se pueden combinar entre ellos.

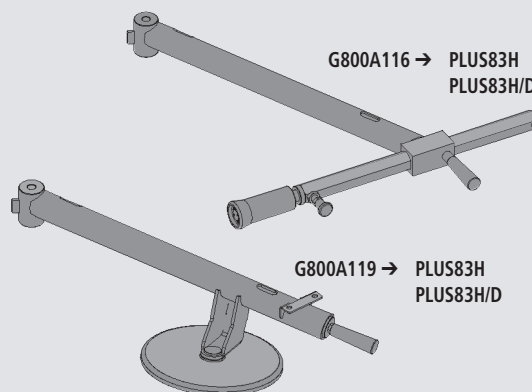

PLUS83H/D

PLUS83H con pressore sagomato WDK
PLUS83H with WDK bead pressure device
 PLUS83H mit WDK-Wulstniederhalter
PLUS83H avec outil de pression WDK
 PLUS83H con prensa talón WDK

OPTIONS → PLUS83H/D

G1000A11



G1000A36

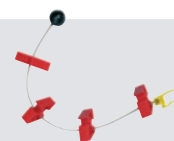

G1000A100K
 (50 x kit)



G800A32



G800A49



G800A51



G800A114



G800A58



OPTIONS → PLUS73

PLUS73

Dispositivo premi-alza tallone pneumatico con braccio rotante.
Air-driven helper with rotating arm.
 Pneumatischer Hilfsmontagearm mit Zusatzhilfsarm.
Dispositif pousse-lève talon pneumatique avec bras rotatif.
 Dispositivo prensa talón neumático con brazo rotatorio.

G800A127

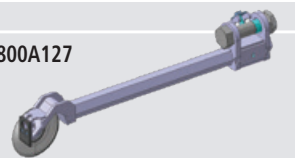

Braccio con disco WDK inclinato 45°
Arm with WDK 45° tilted roller
 Arm mit WDK 45° geneigte Rolle
Bras avec rouleau WDK incliné 45°
 Brazo con rodillo inclinado 45°

Helper (per smontagomme semi-automatici) (for swing arm tyre changers)

PLUS91N

Dispositivo premi-alza tallone pneumatico con braccio rotante
Pneumatic helper with rotating arm
 Pneumatischer Hilfsmontagearm auch mit Hebefunktion
Bras pousse-et leve-talon rotatif pneumatique
 Dispositivo neumático prensa y levanta talón rotatorio

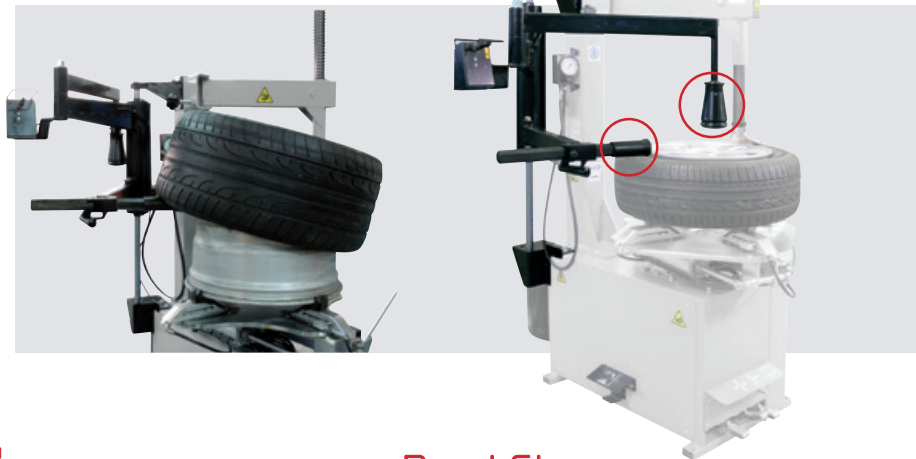

Bead Blaster Protection Protezione Intallamento



G800A100 → PLUS83, PLUS91N

Protezione utilizzatore raccomandata durante l'intallamento e il gonfiaggio.
User protection recommended during bead blasting and inflation.
 Empfohlener Benutzerschutz während der Reifenbefüllung.
Protection utilisateur pendant le gonflage et le positionnement des talons.
 Protección usuario durante entalonamiento y inflado.

Bead Clamp



G84A13

Morsetto blocca tallone.
Bead-locking clamp.
 Wulstklamme.
Etau bloque-talon.
 Mordaza bloquea talón.

Magic Cord

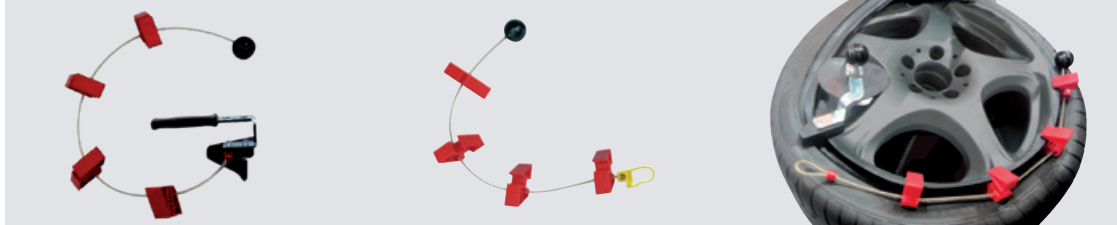

G1000A32

Premitalone 24" con trazione.
24" bead pushing device with pulling system.
 Wulstboy 24" mit Zugvorrichtung.
Pousse-talon 24" avec traction.
 Prensa talón 24" con tracción.

G1000A36 (→ G1000A32)

Extension (24" → 28")

Esempio di utilizzo

How to use
 Gebrauchsbeispiel
Exemple de utilisation
 Ejemplo de utilizo

Tool Roller



G800A18

Rullino premitallone per tutte le macchine in versione standard senza attacco rapido e G800A72.
Bead pushing roller for all standard models without tool quick coupling and G800A72.
 Wulstniederhalte Rolle für alle Maschinen mit Montagekopf ohne Schnellsteckvorrichtung und G800A72.
Rouleau pousse-talon. Pour tous les modèles version standard sans raccord rapide et G800A72.
 Rodillo prensa talón. Para todos los modelos en versión estándar sin enganche rápido y G800A72.

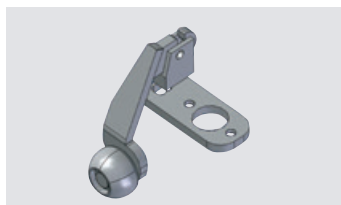

G800A18PS

Rullino premitallone per tutte le macchine in cui è montato l'attacco rapido con testina in plastica o acciaio.
Bead pushing roller for all models with tool (plastic or steel) quick coupling.
 Wulstniederhalte Rolle für alle Maschinen mit Montagekopf mit Schnellsteckvorrichtung.
Rouleau pousse-talon. Pour tous les modèles avec raccord rapide avec outil en acier ou synthétique.
 Rodillo prensa talón. Para todos los modelos que llevan el enganche rápido con útil de plástico o de acero.



Esempio di utilizzo

How to use
 Gebrauchsbeispiel
Exemple de utilisation
 Ejemplo de utilizo

Utensile in plastica stand-alone / Stand-alone plastic tool



Smontagomme automatici / Tilt back tyre changers

G800A126

Utensile in plastica con staffa (kit prima installazione) - posizione utensile fissa
Plastic tool with support (first time kit) - fixed tool position
 Kunststoffmontagekopf mit Halterung (erster Aufrüstsatz) - Kopf mit einer Position
Tête en matériel synthétique VL avec moyeu de raccord à l'arbre - position fixe
 Util de plástico con casquillo de soporte (kit primera instalación) - posición del útil fija

140440311

Utensile in plastica (ricambio)
Plastic tool only (for replacement)
 Kunststoffmontagekopf (für den Ersatz)
Tête en matériel synthétique VL avec position fixe, pour remplacement
 Util de plástico de repuesto



Smontagomme a bandiera / Swing arm tyre changers

G800A60

Utensile in plastica con staffa (kit prima installazione) - doppia posizione utensile
Plastic tool with support (first time kit) - two position tool
 Kunststoffmontagekopf mit Halterung (erster Aufrüstsatz) - Kopf mit zwei Positionen
Tête en matériel synthétique VL avec moyeu de raccord à l'arbre - double position
 Util de plástico con casquillo de soporte (kit primera instalación) - doble posición del útil

770011650

Utensile in plastica (ricambio)
Plastic tool only (for replacement)
 Kunststoffmontagekopf (für den Ersatz)
Tête en matériel synthétique VL double position, pour remplacement
 Util de plástico de repuesto

Position 1



Position 2



Kit attacco rapido / Quick change kits



G800A70

Kit attacco rapido utensili (senza utensile)
Kit for quick change of all tools (without tool)
 Schnellsteckvorrichtung (ohne Montagekopf)
Kit raccord rapide (sans outil)
 Juego enganche rápido (sin útil)



Esempio di utilizzo
How to use
 Gebrauchsbeispiel
Example de utilisation
 Ejemplo de utilizzo



ATTENTION

Il G800A70 riduce il campo di lavoro di 2".
G800A70 reduces max working range by 2".
 Der Einsatz vom G800A70 reduziert die max. Radbreite um 2".
Le kit G800A70 réduit le hauteur maxi de 2".
 El juego G800A70 reduce la altura máxima de rueda de 2"

STANDARD → G800A70

Supporto a due posizioni
Two position support
 Halter mit zwei Positionen
Support pour deux têtes
 Doble soporte

Chiave / Tool
Werkzeug / Outil / Llave

Accessori / Accessories → G800A70



G800A72

Utensile in plastica auto con mozzo per attacco rapido.
Car plastic tool with hub for quick coupling.
 PKW-Kunststoffmontagekopf mit Adapter für Schnellsteckvorrichtung.
Tête synthétique VL avec moyeu pour raccord rapide.
 Útil en plástico turismos con casquillo para enganche rápido.



G800A74

Utensile in plastica moto con mozzo per attacco rapido.
Motorbike plastic tool with hub for quick coupling.
 Motorrad-Kunststoffmontagekopf mit Adapter für Schnellsteckvorrichtung.
Tête synthétique moto avec moyeu pour raccord rapide.
 Útil en plástico motos con casquillo para enganche rápido.



G800A76

Utensile per ruote ATV con mozzo per attacco rapido.
Tool for ATV wheels with hub for quick coupling.
 Montagekopf für ATV-Reifen mit Adapter für Schnellsteckvorrichtung.
Tête pour roues ATV avec moyeu pour raccord rapide.
 Herramienta para ruedas ATV con casquillo para enganche rápido.



G800A73

Utensile in plastica basculante con mozzo per attacco rapido.
Pivoting plastic tool with hub for quick coupling.
 Freibeweglicher Kunststoffmontagekopf mit Adapter für Schnellsteckvorrichtung.
Tête basculante synthétique avec moyeu pour raccord rapide.
 Útil pivoteante en plástico con casquillo para enganche rápido.



G800A110

Utensile per cerchi con razze sporgenti con mozzo per attacco rapido.
Tool suitable also for rims with protruding spokes with hub for quick coupling.
 Montagekopf geeignet auch für gewölbte Felgen mit Adapter für Schnellsteckvorrichtung.
Tête également approprié pour jantes bombées avec moyeu pour raccord rapide.
 Útil idóneo para llantas con radios hacia fuera con casquillo para enganche rápido.



G800A75

Terminale albero utensile per attacco rapido.
Shaft coupling for quick tool change.
 Montagekopf-Adapter für Schnellsteckvorrichtung.
Terminal arbre outil pour raccord rapide.
 Casquillo para enganche rápido.

Gonfiaggio / Inflation



G84A1
Pistola di gonfiaggio.
Inflation gun.
Reifenfüllpistole.
Pistolet de gonflage.
Pistola de inflado.

G800A96

Kit gonfiaggio (pistola + valvola di gonfiaggio a pressione limitata).
Inflating kit (air gun + pressure reducer valve).
Satz Reifenfüllpistole mit Füllventil mit Druckminderer.
Kit gonflage (pistolet plus soupape de limitation de pression).
Kit inflado (pistolete + válvula limitadora de presión).



G84A2
Pistola di gonfiaggio Michelin.
Michelin inflation gun.
Michelin Reifenfüllpistole.
Pistolet de gonflage Michelin.
Pistola de inflado Michelin.

G84A15N

Kit gonfiaggio rapido Michelin (pistola + valvola di gonfiaggio rapido a pressione limitata).
Quick inflation kit Michelin (air gun + pressure-reduced quick inflating valve).
Satz Michelin-Reifenfüllpistole mit Schnellfüllventil mit Druckminderer.
Kit gonflage rapide Michelin (pistolet plus soupape rapide et lim. pression).
Kit pistola de inflado rapido Michelin (pistola + válvula rapida y limitadora de presión).

Gonfiaggio a pedale / Pedal inflation

Dispositivo di gonfiaggio a pedale, completo di manometro e valvola di gonfiaggio rapido a pressione limitata.

Pedal-operated inflating device, with manometer and pressure-reduced quick inflating valve.

Reifenfüllvorrichtung mit Pedalbetätigung, mit Manometer und Schnellfüllventil mit Druckminderer.

Dispositif de gonflage à pédale, complet de manomètre et soupape de limitation de pression.

Dispositivo de inflado a pedal, completo de manómetro y válvula de inflado rápido con presión limitada.

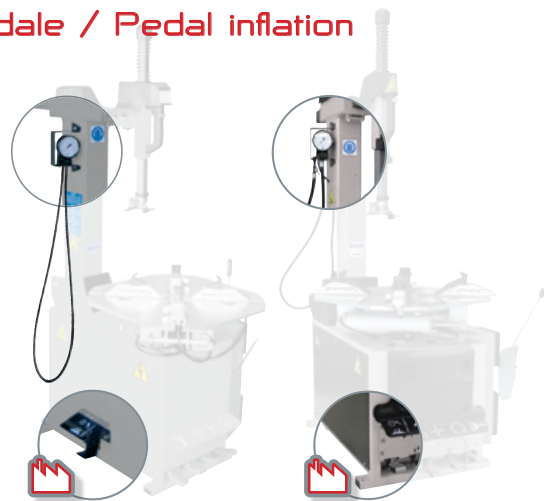

G800A57

G800A123

Intallonamento / Bead-blaster

G800A80 → G800A57
G800A125 → G800A123

Dispositivo di intallamento.
Per smontagomme con gonfiaggio a pedale
Bead-blaster kit.

For tyre changers with pedal inflation
Top-Reifenfüllvorrichtung. Für Montiergeräte mit Pedalbetätigt-Reifenfüllvorrichtung

Dispositif de positionnement talons.
Pour démonte-pneus avec gonflage à pédale

Dispositivo de entalonamiento.
Para desmontadoras con inflado a pedal



Trattamento Aria / Air Treatment



G84A16
Lubrificatore / Lubricator / Ölter /
Lubrificateur / Lubricador



G80A1
Filtro / Filter / Filter /
Filtre / Filtro



G801R
Filtro con regolatore di pressione
Filter with pressure reducer
Filter mit Druckminderer
Filtre avec régulateur de pression
Filtro agua con regulador de presión



G800A13
Regolatore di pressione
Pressure reducer
Druckminderer
Régulateur de pression
Regulador de presión

Moto / Bike



G84A5 (4 x kit) → 18" 20" OLD 22" OLD
G800A99 (4 x kit) → 20" NEW 22" NEW
G800A107 (ex G84A34) (4 x kit) → 24" 26"
Griffe per ruote moto con montaggio rapido (+5" da esterno).
Fast-fit motorcycle wheel clamps (+5" from outside).
Mobile Motorradspannklauen (+5" von aussen).
Griffes pour roues de moto avec montage mobile (+5" de l'extérieur).
Garras para ruedas de moto con montaje móvil (+5" del exterior).

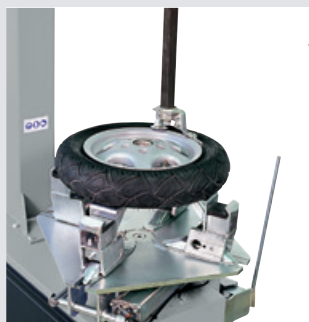

G84A24 (4 x kit) → G84A5
G800A111 (4 x kit) → G800A99, G800A107
Adattatori per riduzione presa griffe (-2", -4" da esterno).
Adaptors for reducing clamping capacity (-2", -4" from outside).
Adapter für Motorradspannklauen (-2", -4" von aussen).
Adaptateur de réduction de la prise (-2", -4" de l'extérieur).
Adaptadores para reducción para garras (-2", -4" del exterior).



G800A78
Paletta stallonatore per ruote moto, di serie su versioni BIKE.
Bead-breaker adaptor for motorcycle wheels, standard on BIKE versions.
Abdrückschaufel für alle Modelle standard auf BIKE.
Détalonneur pour roues moto, d'origine sur versions BIKE.
Paleta destalonadora para ruedas de moto, de serie en los modelos BIKE.

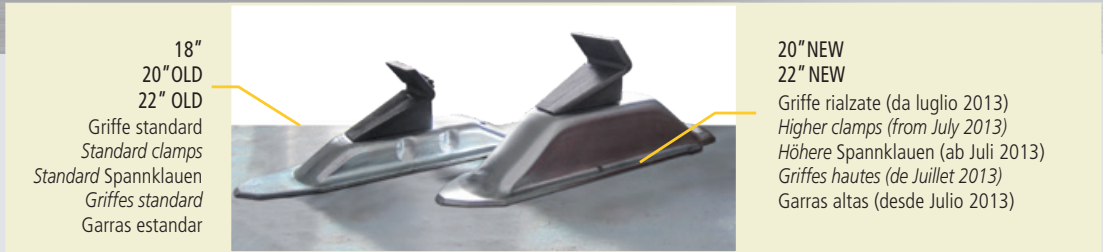

18"
20" OLD
22" OLD
Griffe standard
Standard clamps
Standard Spannklauen
Griffes standard
Garras estandar

20" NEW
22" NEW
Griffe rialzate (da luglio 2013)
Higher clamps (from July 2013)
Höhere Spannklauen (ab Juli 2013)
Griffes hautes (de Juillet 2013)
Garras altas (desde Julio 2013)

Protections / Protezioni

G800A5 (4 x kit) → 18" → 20" OLD → 22" OLD	G800A98 (4 x kit) → 20" NEW → 22" NEW → 24" (fix position)	G800A6 (4 x kit) → 24" (2 positions) → 26" (2 positions) → 30" (2 positions)
G800A5K - Kit 10 x G800A5	G800A98K - Kit 10 x G800A98	G800A6K - Kit 10 x G800A6



Set protezioni griffe - *Clamp protection kit* - Spannklauen-Alufelgenschutz -
Kit protections de griffes - Juego protecciones garras

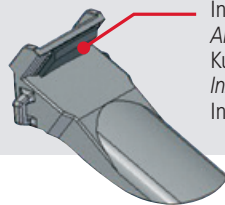

Inserto in plastica anti-slittamento
Anti-skid plastic insert
Kunststoffeinlage für Rutschfestigkeit
Insert plastique anti-glisement
Inserto en plastico anti-deslizante



G800A117 (2 x kit) **QUICK INSERT**
Set protezioni utensile
Tool protection kit
Satz Montagekopf-Alufelgenschutz
Kit de protection outil
Juego protecciones útil
G800A117K - Kit 10 x G800A117



G800A8 (2 x kit) → **LEVERLESS**
Set protezioni utensile
Tool protection kit
Satz Montagekopf-Alufelgenschutz
Kit de protection outil
Juego protecciones útil
G800A8K - Kit 10 x G800A8

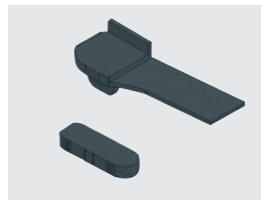

G84A17 (2 x kit) → **G800A110**
Set protezioni utensile
Tool protection kit
Satz Montagekopf-Alufelgenschutz
Kit de protection outil
Juego protecciones útil
G84A17K - Kit 10 x G84A17



G800A11
Protezione paletta stallonatore
Bead breaker blade protection
Abdrückschaufelschutz
Protection détalonneur
Protección paleta destalonadora
G800A11K - Kit 5 x G800A11



G800A32
Protezione tallone per pneumatici
"Run Flat"
Run Flat bead protection
Felgenhornwulstschutz für
"Run Flat-Reifen"
Protection talon pour pneus "Run Flat"
Protección talón para neumáticos
"Run Flat"



G1000A100K (50 x kit)
Confezione di protezioni tallone RFT
(direttiva WDK).
Bead protections for RFT (WDK standard).
WDK-Kit.
Boîte de protections talon RFT (norme WDK).
Juego de protecciones talón ruedas RFT
(norma WDK).



G800A122 (8 x kit)
G800A122K (40 x kit)
Punte sostituibili
Renewable spikes
Austauschbaren Haltekörner
Pointes remplaçables
Puntas reemplazables

Leva Alzatalloni / Bead Lever



G1000A52
Leva alza tallone standard.
Standard bead lever.
Standardmontiereisen.
Levier standard.
Palanca levanta talón estándar.



G1000A11
Leva alzatallone arcuata.
Half moon bead lever.
Halbmondmontiereisen.
Levier demi-lune.
Palanca levanta-talón en forma de "plátano".



G1000A13K (50 x kit) → G1000A52 - G1000A11
Confezione protezioni leva alzatalloni
Bead lever protection package
Satz Montagehebel-Alufelgenschutz
Boîte de protections levier
Confección protecciones palanca levanta talones

Kit Senza-Leva / Leverless Device



G800A81 → xx441
 G800A82 → xx641, xx645
 G800A83 → xx441 + G800A63
 G800A84 → xx645 + G800A68
 G800A85 → xx641 + G800A56

Per smontagomme automatici.
 For tilt back tyre changers.
 Für Automatische Reifenmontiergeräte.
 Pour démonte-pneus automatiques.
 Para desmontadoras automaticas.

Vari / Various



G800A35
 Sollevatore pneumatico ruote.
 Pneumatic wheel lifter.
 Pneumatischer Radheber.
 Élévateur pneumatique de roue.
 Elevador neumático ruedas



G800A37 (3,5 kg / 8 lb)
 Pasta di montaggio.
 Mounting grease.
 Montagepaste.
 Pâte de montage.
 Jabón profesional.
 NOTE: 8 x carton
 160 x pallet



G800A38
 Pennello.
 Brush.
 Schmierpinsel.
 Pinceau.
 Brocha.



G800A56 → xx641
 G800A109 → xx643
 G800A68 → xx645

Movimento pneumatico dell' utensile.
 Pneumatic movement of the tool.
 Pneumatische Werkzeugbewegung.
 Actionnement pneumatique de l'outil.
 Movimento neumático de l'util.



G800A77
 Vaschetta porta-oggetti
 Storage tray
 Ablagemoeglichkeit
 Support accessoires
 Portaobjetos

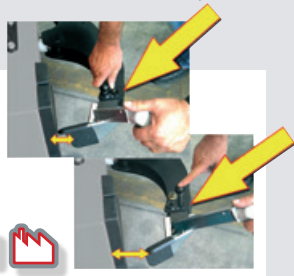

G800A26
 Paletta stallonatore con regolazione inclinazione.
 Bead -breaker adaptor with tilting adjustment.
 Abdrückschaufel mit einstellbaren Abdruckwinkel.
 Détalonneur avec inclinaison réglable.
 Pala destalonadora con regulación inclinación.



G800A101 - G800A102
 Azionamento stallonatore sulla pala
 Bead breaker control by lever
 Hebel-Abdrückschaufelbetätigung
 Commande d'actionnement par levier
 Accionamiento destalonador sobre la pala



G1000A115
 Limitatore corsa stallonatore
 Bead-breaker stroke limiter
 Abdrückschaufelbegrenzer
 Limiteur de course détalonneur
 Limitador de carrera destalonador