

• **TRAVERSE • WHEEL-FREE JACKS • ACHSHEBER**
 • **TRAVERSES DE LEVAGE • GATOS DE ELEVACIÓN**



Fare riferimento al listino prezzi per i codici dei ponti dove utilizzare ogni traversa.
 See pricelist for lifts applicability of each wheel free jack.
 Siehe Preisliste für den genauen Einsatz auf Hebebühnentyp.
 Voir le tarif pour les références des élévateurs ou utiliser chaque traverse.
 Ver la lista de precios para las referencias de los elevadores donde utilizar cada gato.

- Grande corsa di sollevamento
- Dispositivo di traslazione su rulli elastici
- Dispositivo di arresto meccanico ad inserimento automatico e sblocco manuale
- Comando di discesa a due mani, a uomo presente
- *Great lifting height*
- *Translation device on elastic rollers*
- *Automatically-engaging and pneumatic-release mechanical lock device*
- *Two-hand "deadman" lowering control*
- Grosser Hublauf
- Translationsvorrichtung auf Federrollen
- Mechanische Stützeinrichtung mit automatischer Einrastung und pneumatischer Entriegelung
- Zweihand-Absenksteuerung mit Totmannsystem
- *Grande course de levage.*
- *Dispositif de translation sur rouleaux élastiques.*
- *Dispositif d'arrêt mécanique à introduction automatique et dégagement manuel.*
- *Commande de descente à deux mains de type "homme mort".*
- Grande altura de elevación.
- Dispositivo de traslación sobre rodillos elásticos.
- Dispositivo de bloqueo mecánico a inserción automática y desbloqueo manual.
- Mando de bajada a dos manos de tipo hombre presente.



J20 PNX



J20 Series - 2.000 kg

manual	air hydraulic (6-10 bar)	air-hydraulic large (6-10 bar)	
M	P	P	
J20NX	J20PNX	J20PNXL	<p>Not 8 ton Open Front</p> <p>Extra low</p> <p>600 Series (not for 600N Series)</p>
	J20PNR	J20PNRL	<p>600 Series (not for 600N Series)</p> <p>Vedi listino/See price list</p>
	J520PR	J520PRL	<p>600N Series</p>

M

Traversa idraulica con pompa a mano
 Hydraulic wheel-free jack with hand-pump
 Hydraulischer Achsheber mit Handpumpe
 Traverse hydraulique avec pompe manuelle
 Gato hidráulico con bomba de mano

P

Traversa pneumoidraulica
 Air-hydraulic wheel-free jack
 Lufthydraulischer Achsheber
 Traverse hydro-pneumatique
 Gato neumohidráulico

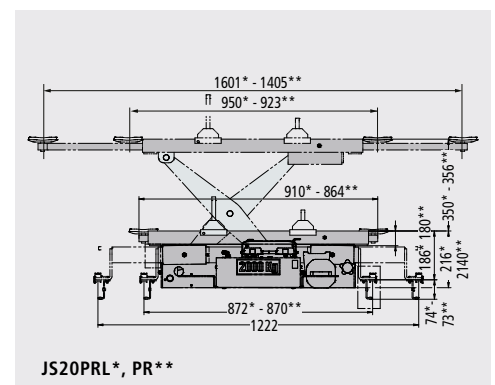
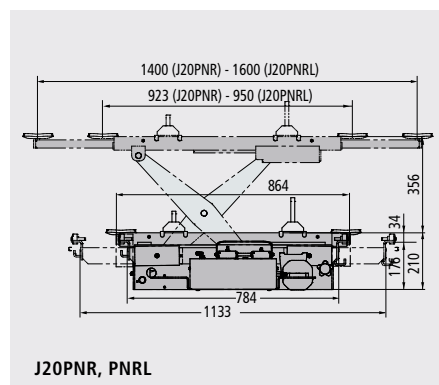
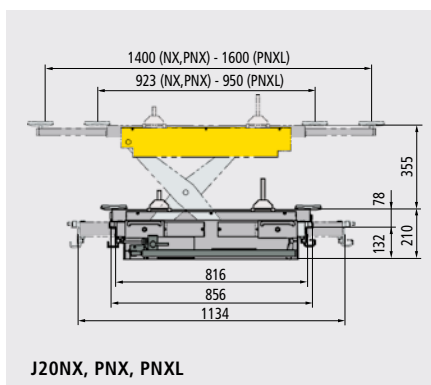



J17X

JS17 - J17X - 2.000 kg

- Azionamento tramite pompa a mano.
- Dispositivo di arresto meccanico ad inserimento automatico e sblocco manuale
- Comando di discesa a due mani, a uomo presente
- Operated by means of hand-pump
- Automatically-engaging and hand-released mechanical lock device
- Two-hand "deadman" lowering control
- Antrieb über Handpumpe
- Mechanische Stützvorrichtung mit automatischer Einrastung und pneumatischer Entriegelung
- Zweihand-Absenksteuerung mit Totmannsystem
- Actionnement au moyen d'une pompe manuelle
- Dispositif d'arrêt mécanique à introduction automatique et dégagement manuel.
- Commande de descente à deux mains de type "homme mort".
- Accionamiento a través de bomba de mano
- Dispositivo de bloqueo mecánico a inserción automática y desbloqueo manual.
- Mando de bajada a dos manos de tipo hombre presente.

manual large

M

J17X

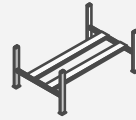

Not 8 ton



600 Series
(not for 600N Series)



Extra low

JS17



600N Series

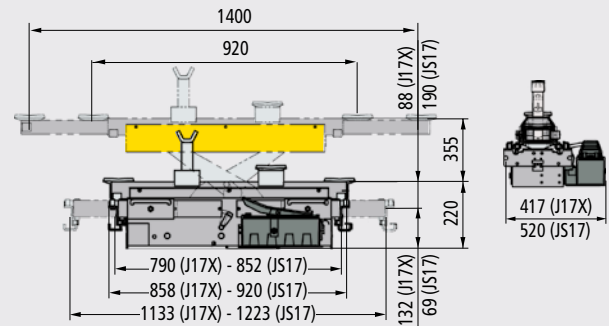

KP111X - 1000 kg

Traversa pneumatica.
Pressione massima 5 bar.
Pneumatic wheel-free jack.
Max pressure 5 bar.
Pneumatischer Achsheber.
Max. Druck 5 bar.
Traverse pneumatique.
Pression maxi 5 bars.
Gato neumático.
Presión máxima 5 bares.

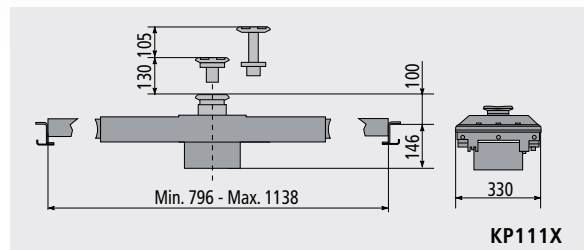
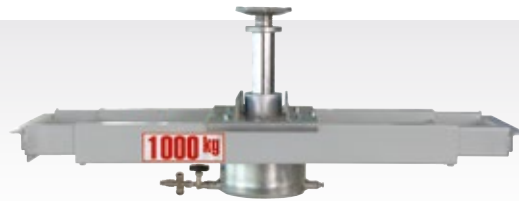

KP111X

air hydraulic (5 bar)

P



KP111X



Not 8 ton



600 Series
(not for 600N Series)

J50 SERIES - 5.000 kg

- Grande corsa di sollevamento
- Great lifting height
- Grosser Hublauf
- Grande course de levage
- Grande altura de elevación



J50 PHA

air-hydraulic
(6-10 bar)

P



J50PHA

4 colonne elettroidraulici / Electro-hydraulic 4-post lifts /
Elektrohydraulische 4-Säulen Hebebühnen / 4 colonnes
électro-hydrauliques / 4 columnas electrohidráulicos
→ 6,5 ton + S4651LA1
→ 8 ton + S4800A4

J50PHT

→ Sollevatori a forbice per camion / Truck scissor
lifts / Scherenbehebühnen für LKW / Élévateurs a
ciseaux pour véhicules industriels / Elevadores da
tijera para vehículos industriales

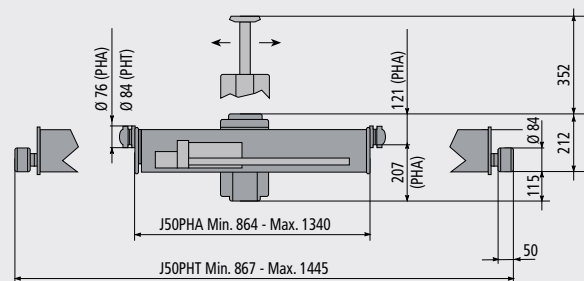







J30PXL



J40 PXL





J30 Series - 3.000 kg

manual	air hydraulic (6-10 bar)	air-hydraulic large (6-10 bar)	
M	P	P	
J30X	J30PX	J30PXL	→  ≥ 4 Ton - not 8 ton
J30R Ribassata / Extra low / Extra niedrig Extra plat / Extra baja	J30PR	J30PRL	→  ≥ 4 Ton (600 Series) Open Front
	JS30PR	JS30PRL	→  600N Series
	J30PK	J30PKL	→  8 Ton + S4800A4

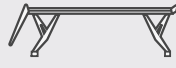
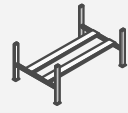

J40 Series - 4.000 kg P

air-hydraulic large (6-10 bar)

J40PY	→ 	
J40PXL	→ 	6,5 Ton Open Front
J40 PRL Ribassata Extra low Extra niedrig Extra plat Extra baja	→ 	≥ 6 Ton 600 Series (not for 600N Series)
JS40PRL	→ 	≥ 6 Ton 600N Series
J40 PKL	→ 	8 ton + S4800A4

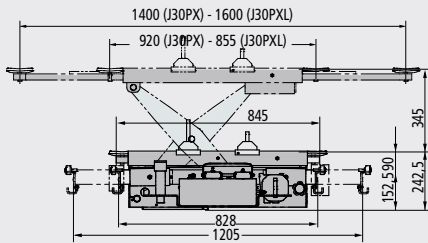

J30X - J30PX - J30PXL

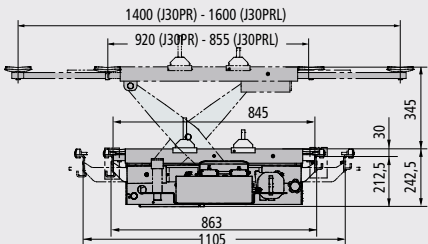

J30R - J30PR - J30PRL

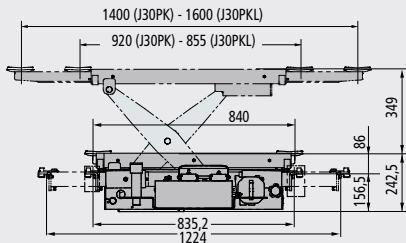

J30PK - J30PKL

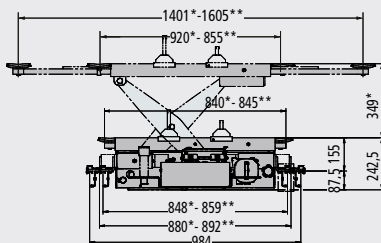

JS30PR* - JS30PRL**

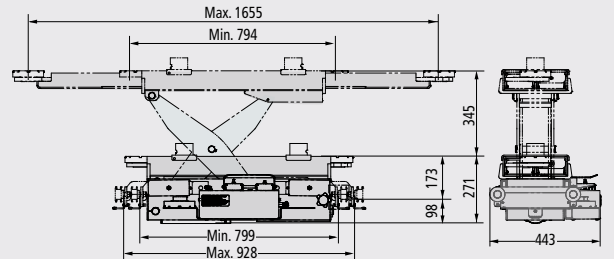

J40PY

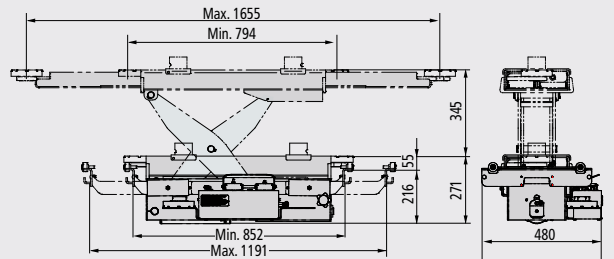

J40PXL

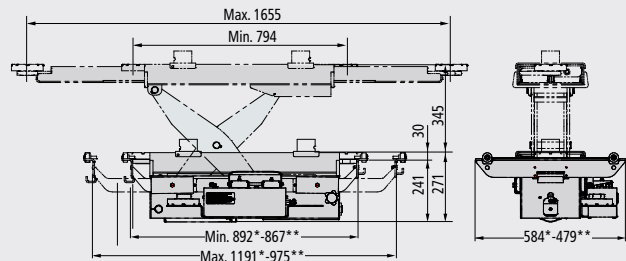

J40PRL* - JS40PRL**

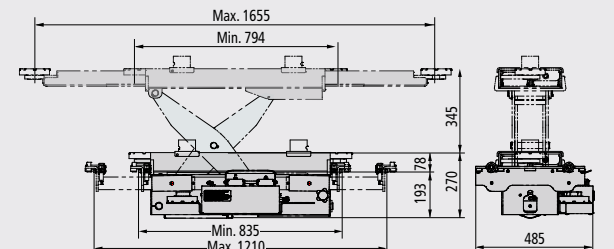

J40PKL

KP118NP - 13.500 kg

KP118/440P - 13.500 kg

Idropneumatica - Air-hydraulic - Lufthydraulisch
Hydro-pneumatique - Neumohidráulico



KP118/440P e KP118NP

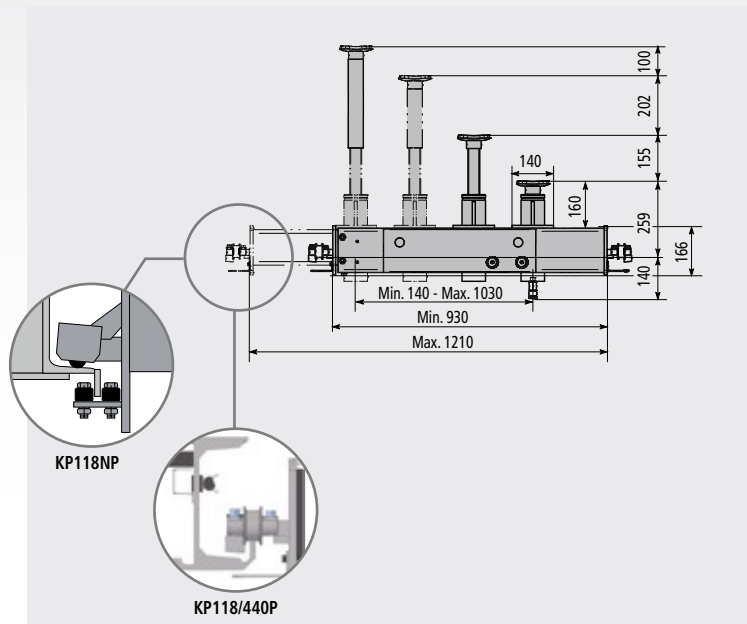

air-hydraulic
(6-10 bar)

P



→ Sollevatori elettromeccanici a 4 colonne / Electro-mechanical 4 post lifts / Elektromechanische 4-Säulen-Hebebühnen / Elevateurs electromecaniques 4 colonnes / Elevadores electromecánicos de 4 columnas

KP118 NP (→ 12 ton, 14 ton)

KP118/440P (→ 24 ton)

KP118 - 13.500 kg

Pompa a mano - Hand pump - Handpumpe
Pompe manuelle - Bomba de mano

KP118 P - 13.500 kg

Idropneumatica - Air-hydraulic - Lufthydraulisch
Hydro-pneumatique - Neumohidráulico

	air-hydraulic (6-10 bar)	
manual	P	
M	P	
KP118	KP118 P	fossa - pit - Grube - fosse - foso

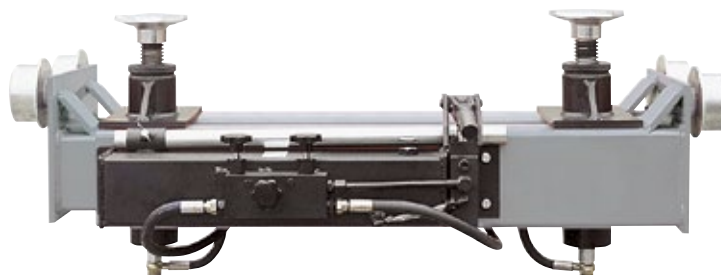

KP 118

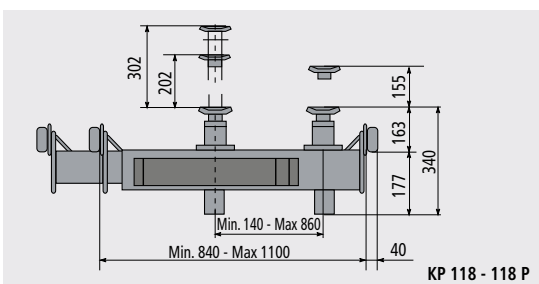

KP 118 - 118 P



KP 118 P

STANDARD: KP118, KP118P, KP118NP

